

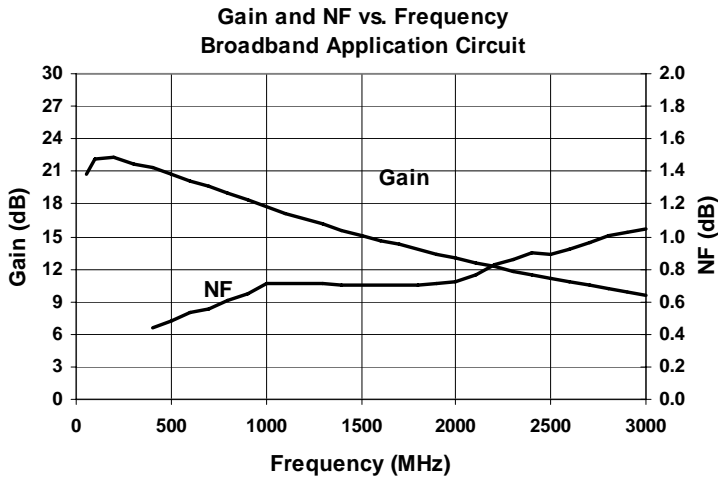

Product Description

The SPF-5043Z is a high performance pHEMT MMIC LNA designed for operation from 400-3000 MHz. The on-chip active bias network provides stable current over temperature and process threshold voltage variations. The SPF-5043Z offers ultra-low noise figure and high linearity performance in a gain block configuration. Its single-supply operation and integrated matching networks make implementation remarkably simple. High maximum input power specification make it ideal for high dynamic range receivers.



Advanced Information

SPF-5043Z

400-3000 MHz, GaAs pHEMT Low Noise MMIC Amplifier



Product Features

- Ultra-Low Noise Figure = 0.6 dB @ 900 MHz
- Gain = 18.5 dB @ 900 MHz
- High Linearity: OIP₃ = 35 dBm @ 1900 MHz
- P1dB = 22 dBm @ 1900 MHz
- Single-supply operation: 5V @ I_{dq}=45mA
- Broadband Internal Matching
- RoHS/WEEE Compliant SOT-343 package

Applications

- Cellular, PCS, W-CDMA, ISM, W iMAX Receivers
- Low noise, high linearity gain block applications

Symbol	Parameters	Units	Frequency	Min.	Typ.	Max.
S ₂₁	Small Signal Power Gain	dB	0.9 GHz		18.3	
			1.9 GHz		13.4	
NF	Noise Figure	dB	0.9 GHz		0.65	
			1.9 GHz		0.70	
OIP ₃	Output Third Order Intercept Point	dBm	0.9 GHz		32.5	
			1.9 GHz		34.5	
P1dB	Output Power at 1dB Compression	dBm	0.9 GHz		21.0	
			1.9 GHz		21.8	
S ₁₁	Input Return Loss	dB	0.9 GHz		-13.5	
			1.9 GHz		-14.5	
S ₂₂	Output Return Loss	dB	0.9 GHz		-24.5	
			1.9 GHz		-19.5	
S ₁₂	Reverse Isolation	dB	0.9 GHz		-24.5	
			1.9 GHz		-20.0	
V _D	Device Operating Voltage	V			5.0	
I _{DQ}	Device Operating Current (Quiescent)	mA			45	
R _{th, j-l}	Thermal Resistance (junction-to-lead)	°C/W			125	

Test Conditions: V_S = 5.0V, I_{DQ} = 45mA, OIP₃ Tone Spacing = 1MHz, P_{out} per tone = 0 dBm
Z_S = Z_L = 50 Ohms, 25C, Broadband Application Circuit

The information provided herein is believed to be reliable at press time. Sirenza Microdevices assumes no responsibility for inaccuracies or omissions. Sirenza Microdevices assumes no responsibility for the use of this information, and all such information shall be entirely at the user's own risk. Prices and specifications are subject to change without notice. No patent rights or licenses to any of the circuits described herein are implied or granted to any third party. Sirenza Microdevices does not authorize or warrant any Sirenza Microdevices product for use in life-support devices and/or systems. Copyright 2006 Sirenza Microdevices, Inc.. All worldwide rights reserved.

Typical RF Performance (with Broadband Application Circuit)

Symbol	Parameter	Unit	Frequency (GHz)							
			0.4	0.8	0.9	1.0	1.9	2.2	2.5	3.0
S ₂₁	Small Signal gain	dB	21.3	18.9	18.3	17.8	13.4	12.2	11.1	9.6
NF	Noise Figure	dB	0.45	0.60	0.65	0.70	0.70	0.85	0.90	1.05
OIP ₃	Output Third Order Intercept Point	dBm	30.5	31.5	32.5	32.0	34.5	34.5	36.0	36.5
P1dB	Output Power at 1dB compression	dBm	20.4	20.7	21.0	20.9	21.8	22.3	22.4	22.6
S ₁₁	Input Return Loss	dB	-11.0	-13.0	-13.5	-13.5	-14.5	-14.5	-14.0	-12.0
S ₂₂	Output Return Loss	dB	-18.5	-23.5	-24.5	-24.5	-19.5	-18.5	-17.5	-17.0
S ₁₂	Reverse Isolation	dB	-26.0	-24.5	-24.5	-24.5	-20.0	-19.0	-18.0	-17.0

Test Conditions: V_S=5.0V I_{DC}=45mA OIP₃ Tone Spacing = 1MHz Pout per tone = 0 dBm T_L = 25°C Z_S = Z_L = 50Ohms

Reliability & Qualification Information		Absolute Maximum Ratings	
Parameter	Rating	Parameter	Absolute Limit
ESD Rating - Human Body Model (HBM)	Class 1A	Max Device Current (I _D)	60mA
Moisture Sensitivity (MSL)	MSL 1	Max Device Voltage (V _D)	5.5V
This product qualification report can be downloaded at: www.sirenza.com		Max RF Input Power	25dBm
		Max Dissipated Power	330mW
		Max Junction Temperature (T _J)	150°C
		Operating Temperature Range (T _L)	-40 to +85°C
		Max Storage Temp.	-65 to +150°C

Typical Performance (with Broadband Application Circuit)

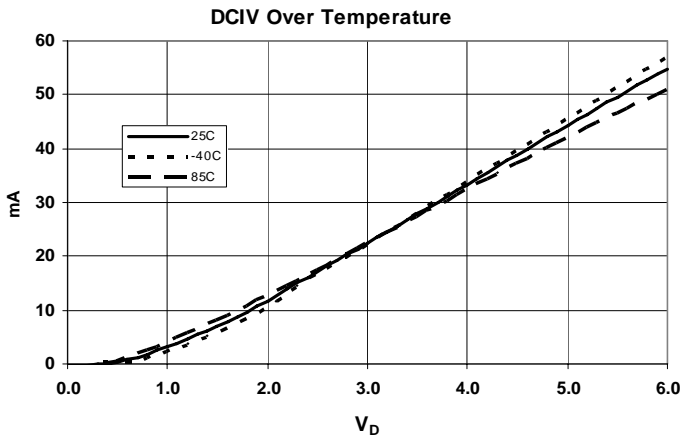

Operation of this device beyond any one of these limits may cause permanent damage. For reliable continuous operation, the device voltage and current must not exceed the maximum operating values specified in the table on page one.

Bias Conditions should also satisfy the following expression:

$$I_D V_D < (T_J - T_L) / R_{TH, j-l} \quad T_L = \text{Source lead Temperature}$$



Caution: ESD sensitive

Appropriate precautions in handling, packaging and testing devices must be observed.

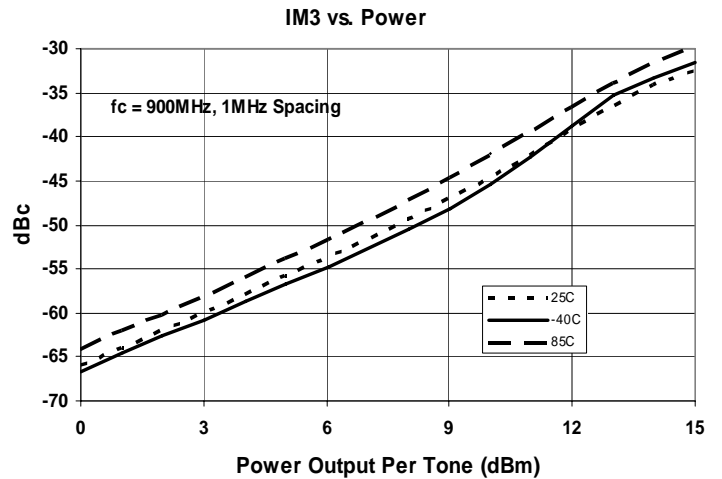
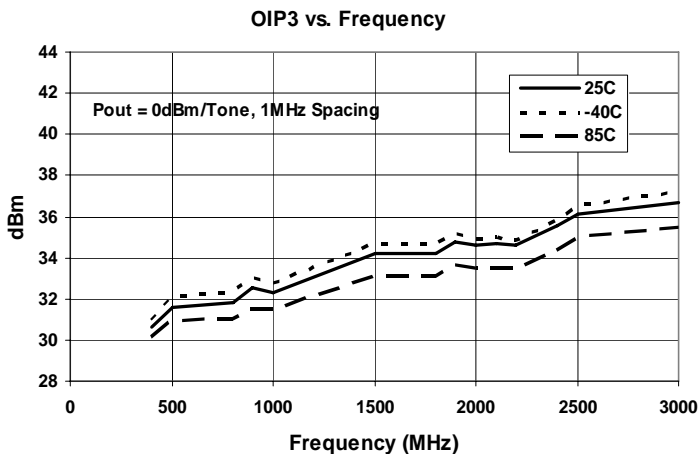

Typical RF Performance (Broadband Application Circuit, 5V, 45mA)

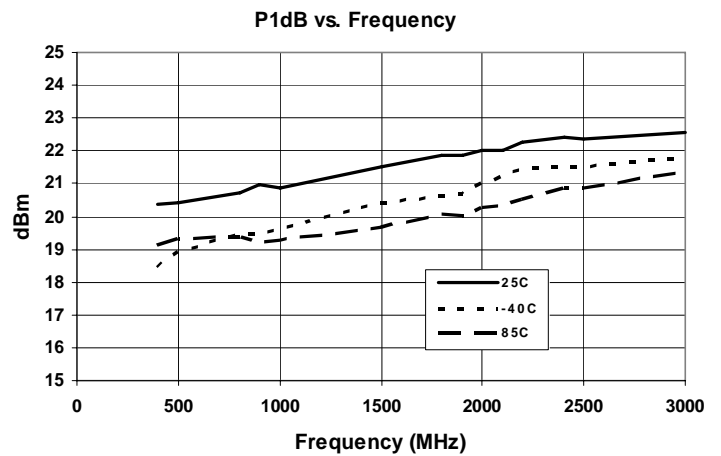
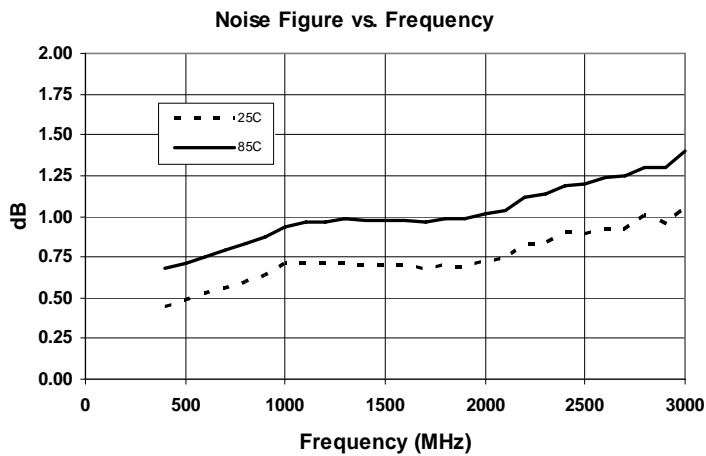
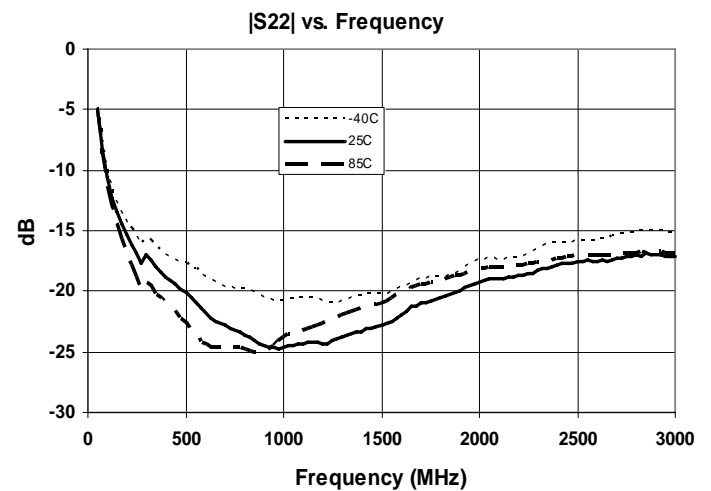
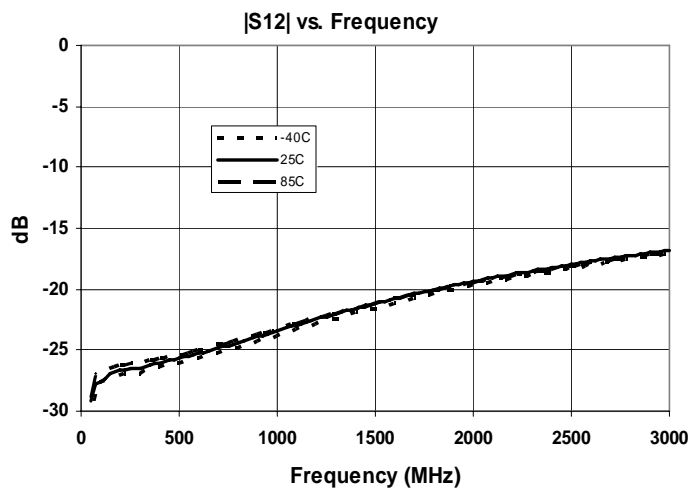
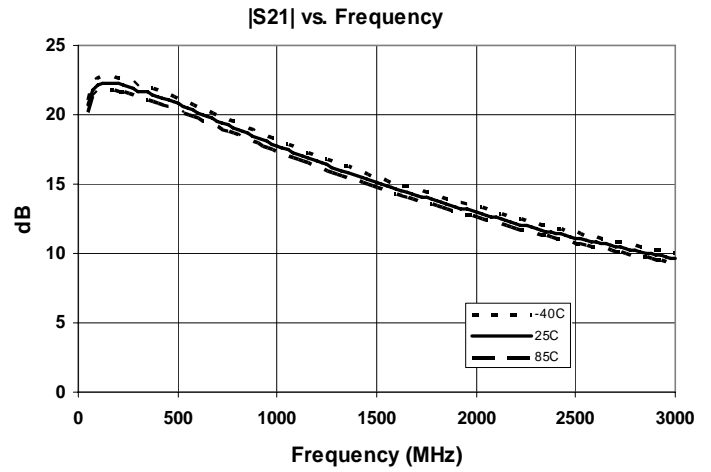
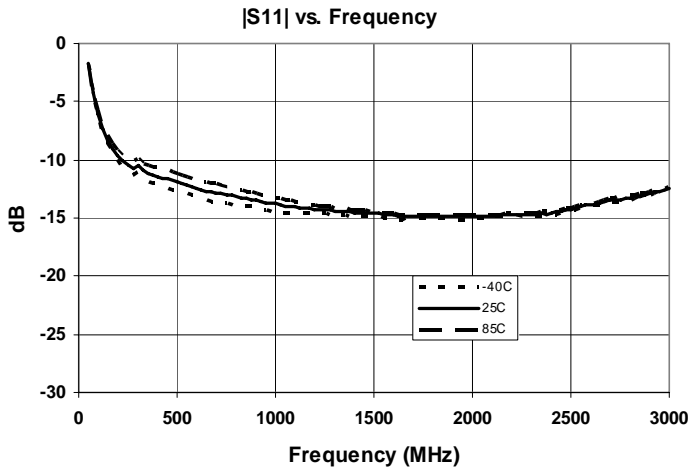

Typical Performance De-embedded S-parameters (5V, 45mA)

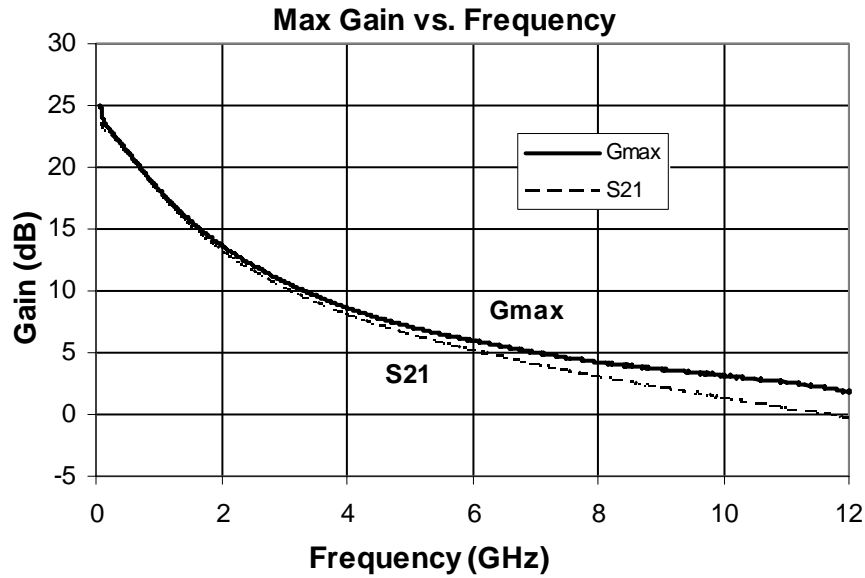

S11 vs. Frequency

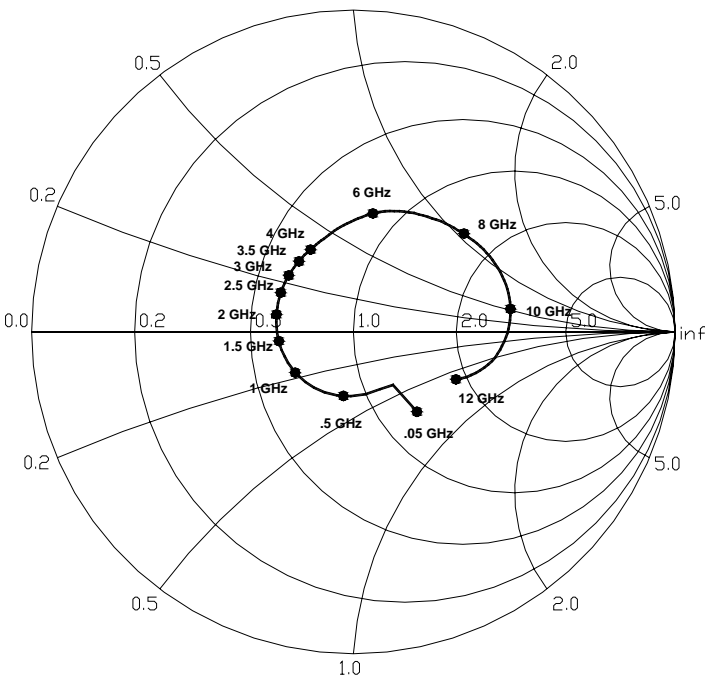

S22 vs. Frequency

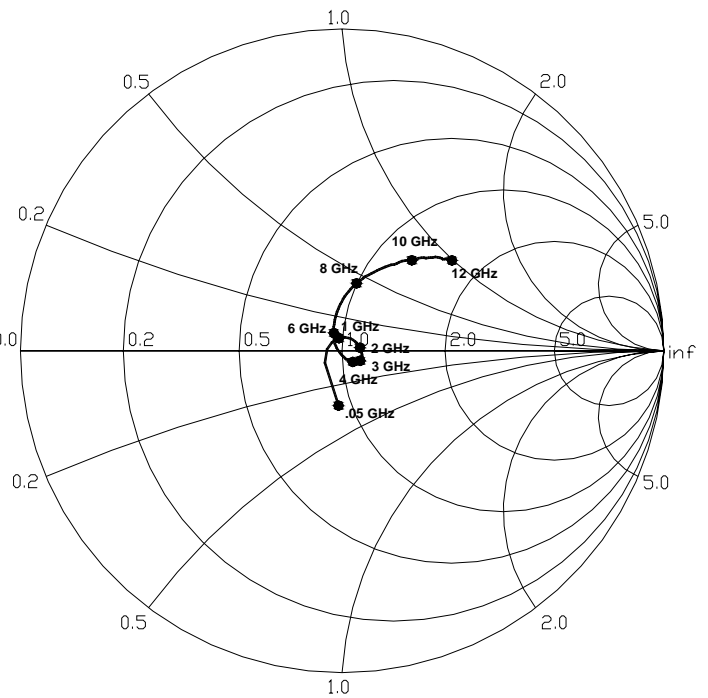

Broadband Application Circuit Schematic (400 - 3000MHz)

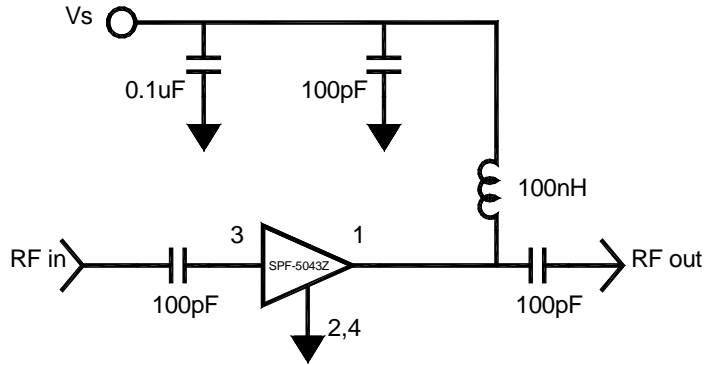

Evaluation Board Layout

Bill of Materials

C1	1x TAJB104KLRH Rohm 0.1uF
C2	1x MCH185A101JK Rohm 100pF
C3	1x MCH185A101JK Rohm 100pF
C4	1x MCH185A101JK Rohm 100pF
L1	1x LL1608-FSR10J Toko 100nH

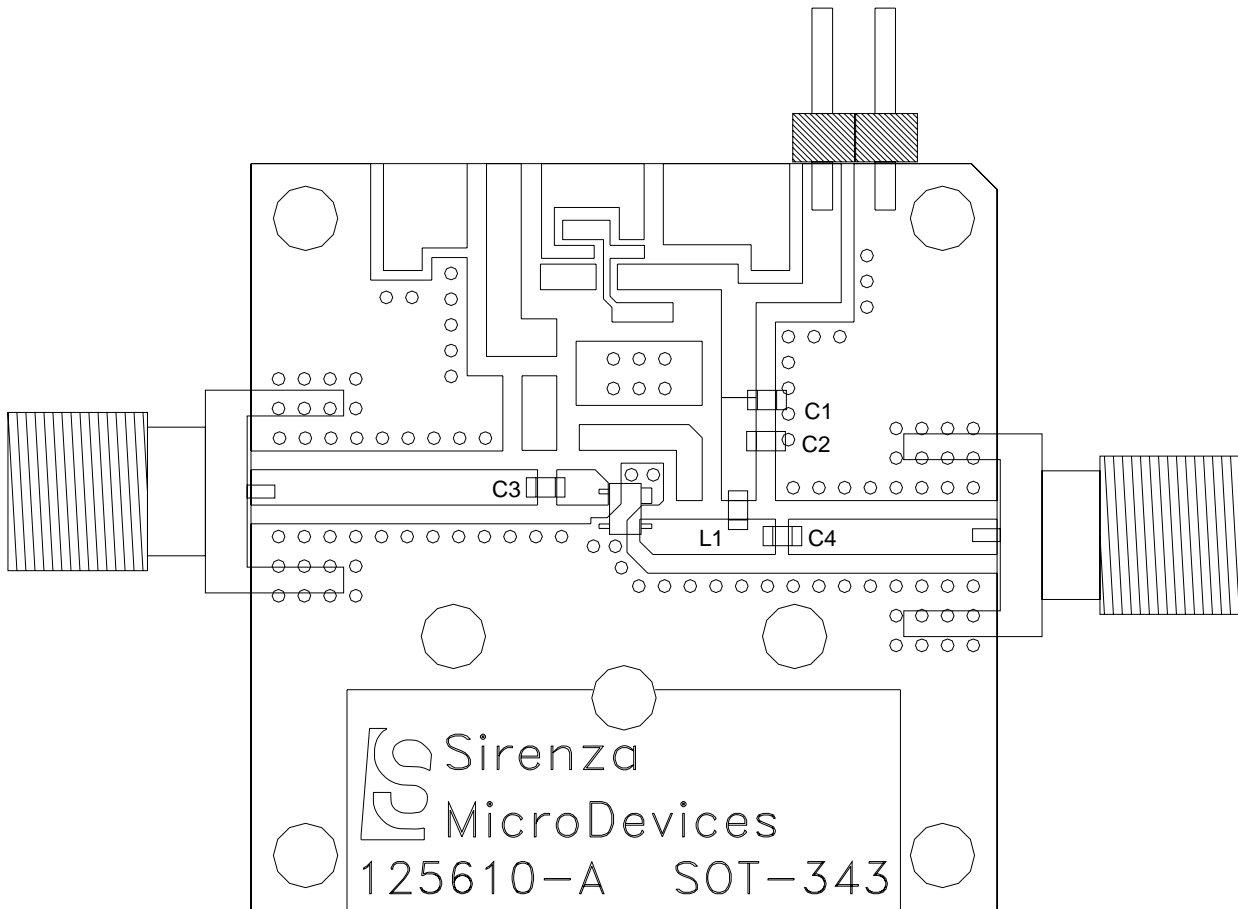

Pad #	Function	Description
1	RF _{OUT} / Bias	RF output and Bias pin. This pin is DC coupled and matched to 50 Ohms. Bias is applied through this pad.
2,4	GND	Connection to ground
3	RF _{IN}	RF input pin. This pin is DC coupled and matched to 50 Ohms. An external DC block is required.

Part Number Ordering Information

Part Number	Reel Size	Devices/Reel
SPF-5043Z	7"	3000

Part Identification

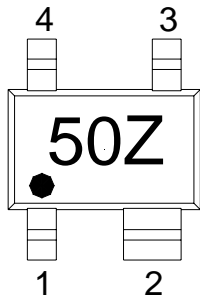

Suggested Pad Layout

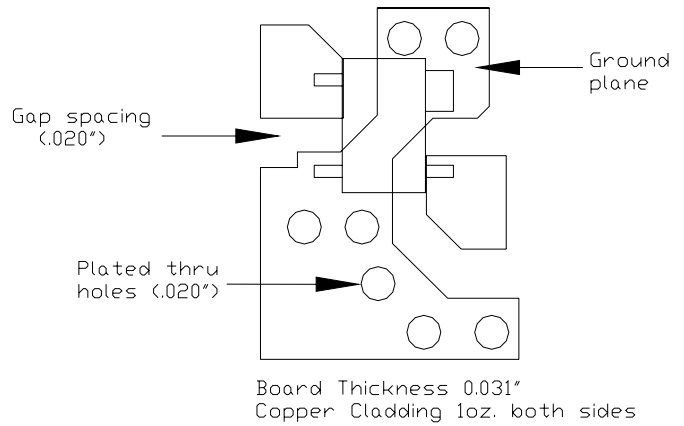

Nominal Package Dimensions

Dimensions in inches [millimeters]
 Refer to drawing posted at www.sirenza.com for tolerances.

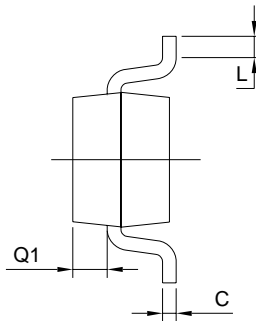
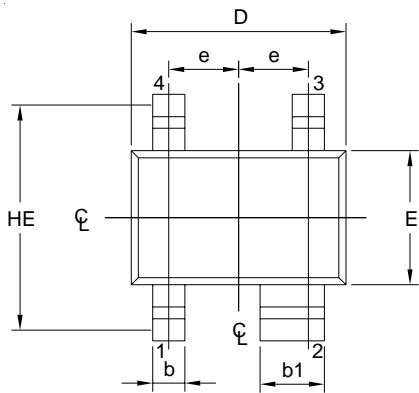

SYMBOL	MIN	MAX
E	1.15	1.35
D	1.85	2.25
HE	1.80	2.40
A	0.80	1.10
A2	0.80	1.00
A1	0.00	0.10
Q1	0.10	0.40
e	0.65 BSC	
b	0.25	0.40
b1	0.55	0.70
c	0.10	0.18
L	0.10	0.30

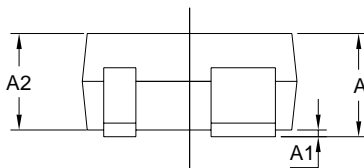

- NOTE:
1. ALL DIMENSIONS ARE IN MILLIMETERS.
 2. DIMENSIONS ARE INCLUSIVE OF PLATING.
 3. DIMENSIONS ARE EXCLUSIVE OF MOLD FLASH & METAL BURR.
 4. ALL SPECIFICATIONS COMPLY TO EIAJ SC70.
 5. DIE IS FACING UP FOR MOLD AND FACING DOWN FOR TRIM/FORM. ie :REVERSE TRIM/FORM.
 6. PACKAGE SURFACE TO BE MIRROR FINISH.